

NATIONAL CHAMPIONSHIP U10 2022 09/04/2022 LEFKOTHEO GIRLS U10-27

Competitors: 5

Competitors

#	Name	Club	1	2	3	4	5	Wins	Pts	Pos
1	ZOI AFXENTIOU	KITION		10		10	10	3	30	2
2	NIKOL MANEVA	CHRISTODOULIDES JUDO ACADEMY						0	0	5
3	PANAGIOTA GRIGORI	ZEN JUDO	10	10		10	10	4	40	1
4	MARIA HAPESHI	LARNAKA JUDO UNION		10				1	10	4
5	MARIANNA STAVROU	ENOSI JUDO AMMOCHOSTOU		10		10		2	20	3

Matches

Match	White			Blue	Result	Time
1	MARIA HAPESHI	4	5	MARIANNA STAVROU	00s1-10	2:00
2	ZOI AFXENTIOU	1	2	NIKOL MANEVA	10-00	0:21
3	PANAGIOTA GRIGORI	3	4	MARIA HAPESHI	10-00s2	1:29
4	ZOI AFXENTIOU	1	5	MARIANNA STAVROU	10-00	0:39
5	NIKOL MANEVA	2	3	PANAGIOTA GRIGORI	00-11	0:54
6	ZOI AFXENTIOU	1	4	MARIA HAPESHI	10-00s1	1:09
7	PANAGIOTA GRIGORI	3	5	MARIANNA STAVROU	10-00	0:19
8	NIKOL MANEVA	2	4	MARIA HAPESHI	00-10	0:16
9	ZOI AFXENTIOU	1	3	PANAGIOTA GRIGORI	01-10	1:52
10	NIKOL MANEVA	2	5	MARIANNA STAVROU	00-10	1:18

Results

Pos	Name
1	PANAGIOTA GRIGORI, ZEN JUDO
2	ZOI AFXENTIOU, KITION
3	MARIANNA STAVROU, ENOSI JUDO AMMOCHOSTOU
4	MARIA HAPESHI, LARNAKA JUDO UNION
5	NIKOL MANEVA, CHRISTODOULIDES JUDO ACADEMY

NATIONAL CHAMPIONSHIP U10 2022 09/04/2022 LEFKOTHEO GIRLS U10-30

Competitors: 5

Competitors

#	Name	Club	1	2	3	4	5	Wins	Pts	Pos
1	ELENI GIANGOU	MOSFILOTI SPORTS CENTER						0	0	5
2	IOUSTINI ANASTASIOU	FIGHTERS CYPRUS SPORTS CLUB	10			10		2	20	3
3	ANASTASIA FRAGIOUDAKI	ONISILOS	10	10		10	10	4	40	1
4	ELEFThERIA PETROU	KITION	10					1	10	4
5	LOUIZA ANTONIOU	KITION	10	10		10		3	30	2

Matches

Match	White			Blue	Result	Time
1	ELEFThERIA PETROU	4	5	LOUIZA ANTONIOU	00-11	0:26
2	ELENI GIANGOU	1	2	IOUSTINI ANASTASIOU	00-10	0:29
3	ANASTASIA FRAGIOUDAKI	3	4	ELEFThERIA PETROU	10-00	0:10
4	ELENI GIANGOU	1	5	LOUIZA ANTONIOU	00s3-10	3:21
5	IOUSTINI ANASTASIOU	2	3	ANASTASIA FRAGIOUDAKI	00-10	0:05
6	ELENI GIANGOU	1	4	ELEFThERIA PETROU	00-10	0:00
7	ANASTASIA FRAGIOUDAKI	3	5	LOUIZA ANTONIOU	10-00	0:27
8	IOUSTINI ANASTASIOU	2	4	ELEFThERIA PETROU	10-00	0:00
9	ELENI GIANGOU	1	3	ANASTASIA FRAGIOUDAKI	00-10	0:00
10	IOUSTINI ANASTASIOU	2	5	LOUIZA ANTONIOU	00-10	1:05

Results

Pos	Name
1	ANASTASIA FRAGIOUDAKI , ONISILOS
2	LOUIZA ANTONIOU, KITION
3	IOUSTINI ANASTASIOU, FIGHTERS CYPRUS SPORTS CLUB
4	ELEFThERIA PETROU, KITION
5	ELENI GIANGOU, MOSFILOTI SPORTS CENTER

NATIONAL CHAMPIONSHIP U10 2022 09/04/2022 LEFKOTHEO GIRLS U10-33

Competitors

Competitors: 2

#	Name	Club	1	2	1	2	1	2	Wins	Pts	Pos
1	MELINA SOTERIOU	CHRISTODOULIDES JUDO ACADEMY		10		10			2	20	1
2	MONICA LUPASCU	PIERO JUDO ACADEMY							0	0	2

Matches

Match	White		Blue		Result	Time
1	MELINA SOTERIOU	1	2	MONICA LUPASCU	11-01s3	1:54
2	MELINA SOTERIOU	1	2	MONICA LUPASCU	10-00s2	1:26
3	MELINA SOTERIOU	1	2	MONICA LUPASCU		

Results

Pos	Name
1	MELINA SOTERIOU, CHRISTODOULIDES JUDO ACADEMY
2	MONICA LUPASCU, PIERO JUDO ACADEMY

NATIONAL CHAMPIONSHIP U10 2022 09/04/2022 LEFKOTHEO GIRLS U10-36

Competitors

Competitors: 3

#	Name	Club	1	2	3	Wins	Pts	Pos
1	ANTREANA SOFIANO	ONISILOS				0	0	3
2	ANTREANA GEORGIU	ONISILOS	10			1	10	2
3	ANASTASIA KYRIAZE	CHRISTODOULIDES JUDO ACADEMY	10	10		2	20	1

Matches

Match	White		Blue	Result	Time
1	ANTREANA SOFIANO	1	2	ANTREANA GEORGIU	00-10 0:31
2	ANTREANA SOFIANO	1	3	ANASTASIA KYRIAZE	00-10 0:17
3	ANTREANA GEORGIU	2	3	ANASTASIA KYRIAZE	01-10 2:00

Results

Pos	Name
1	ANASTASIA KYRIAZE, CHRISTODOULIDES JUDO ACADEMY
2	ANTREANA GEORGIU , ONISILOS
3	ANTREANA SOFIANO , ONISILOS

NATIONAL CHAMPIONSHIP U10 2022 09/04/2022 LEFKOTHEO GIRLS U10-39

Competitors

Competitors: 2

#	Name	Club	1	2	1	2	1	2	Wins	Pts	Pos
1	ELIA KOUTSOFTA	LARNAKA JUDO UNION		1				1	2	2	1
2	DANAE GEORGIU	KERYNIA JUDO UNION			10				1	10	2

Matches

Match	White		Blue		Result	Time
1	ELIA KOUTSOFTA	1	2	DANAE GEORGIU	01s2-00s1	3:31
2	ELIA KOUTSOFTA	1	2	DANAE GEORGIU	01s3-11s2	3:29
3	ELIA KOUTSOFTA	1	2	DANAE GEORGIU	01-00s1	2:00

Results

Pos	Name
1	ELIA KOUTSOFTA, LARNAKA JUDO UNION
2	DANAE GEORGIU, KERYNIA JUDO UNION

NATIONAL CHAMPIONSHIP U10 2022 09/04/2022 LEFKOTHEO GIRLS U10-42

Competitors

Competitors: 2

#	Name	Club	1	2	1	2	1	2	Wins	Pts	Pos
1	SOFIA GERASIMOU	CHRISTODOULIDES JUDO ACADEMY							0	0	2
2	ELLI ANNA SKEMPI	PAPHIAN JUDO UNION	1		10				2	11	1

Matches

Match	White			Blue	Result	Time
1	SOFIA GERASIMOU	1	2	ELLI ANNA SKEMPI	00s1-01	2:00
2	SOFIA GERASIMOU	1	2	ELLI ANNA SKEMPI	00-10	0:34
3	SOFIA GERASIMOU	1	2	ELLI ANNA SKEMPI		

Results

Pos	Name
1	ELLI ANNA SKEMPI, PAPHIAN JUDO UNION
2	SOFIA GERASIMOU, CHRISTODOULIDES JUDO ACADEMY

NATIONAL CHAMPIONSHIP U10 2022 09/04/2022 LEFKOTHEO GIRLS U10-45

Competitors

Competitors: 2

#	Name	Club	1	2	1	2	1	2	Wins	Pts	Pos
1	NEFELI XATZIGEORGIOY	ONISILOS							0	0	2
2	IOANNA TZIAMPOU	ONISILOS	10		10				2	20	1

Matches

Match	White		Blue		Result	Time
1	NEFELI XATZIGEORGIOY	1	2	IOANNA TZIAMPOU	00s1-10s1	1:48
2	NEFELI XATZIGEORGIOY	1	2	IOANNA TZIAMPOU	00-10	0:35
3	NEFELI XATZIGEORGIOY	1	2	IOANNA TZIAMPOU		

Results

Pos	Name
1	IOANNA TZIAMPOU , ONISILOS
2	NEFELI XATZIGEORGIOY , ONISILOS

NATIONAL CHAMPIONSHIP U10 2022 09/04/2022 LEFKOTHEO GIRLS U10+48

Competitors: 6

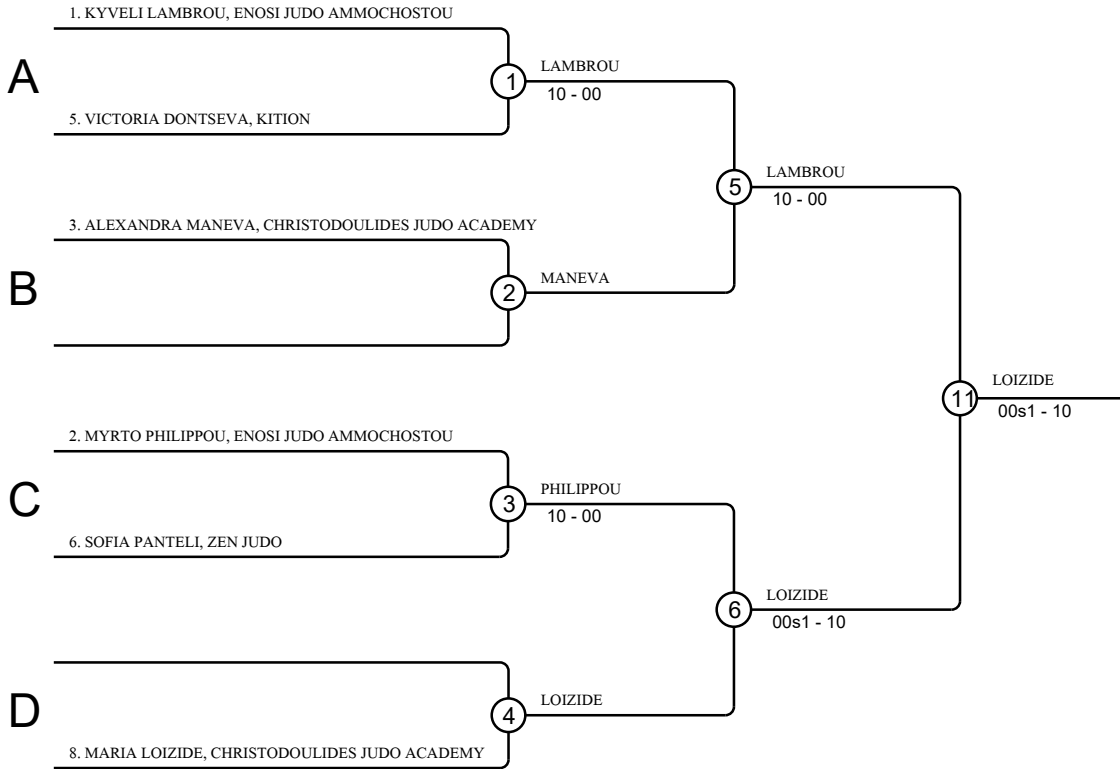

Results

Pos	Name
1	MARIA LOIZIDE, CHRISTODOULIDES JUDO ACADEMY
2	KYVELI LAMBROU, ENOSI JUDO AMMOCHOSTOU
3	VICTORIA DONTSEVA, KITION
3	ALEXANDRA MANEVA, CHRISTODOULIDES JUDO ACADEMY
5	MYRTO PHILIPPOU, ENOSI JUDO AMMOCHOSTOU
5	SOFIA PANTELI, ZEN JUDO
7	
7	

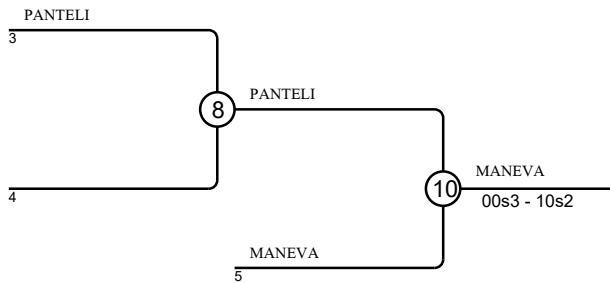
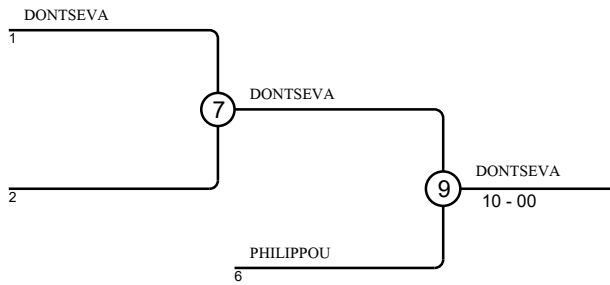

NATIONAL CHAMPIONSHIP U10 2022 09/04/2022 LEFKOTHEO BOYS U10-29

Competitors: 33

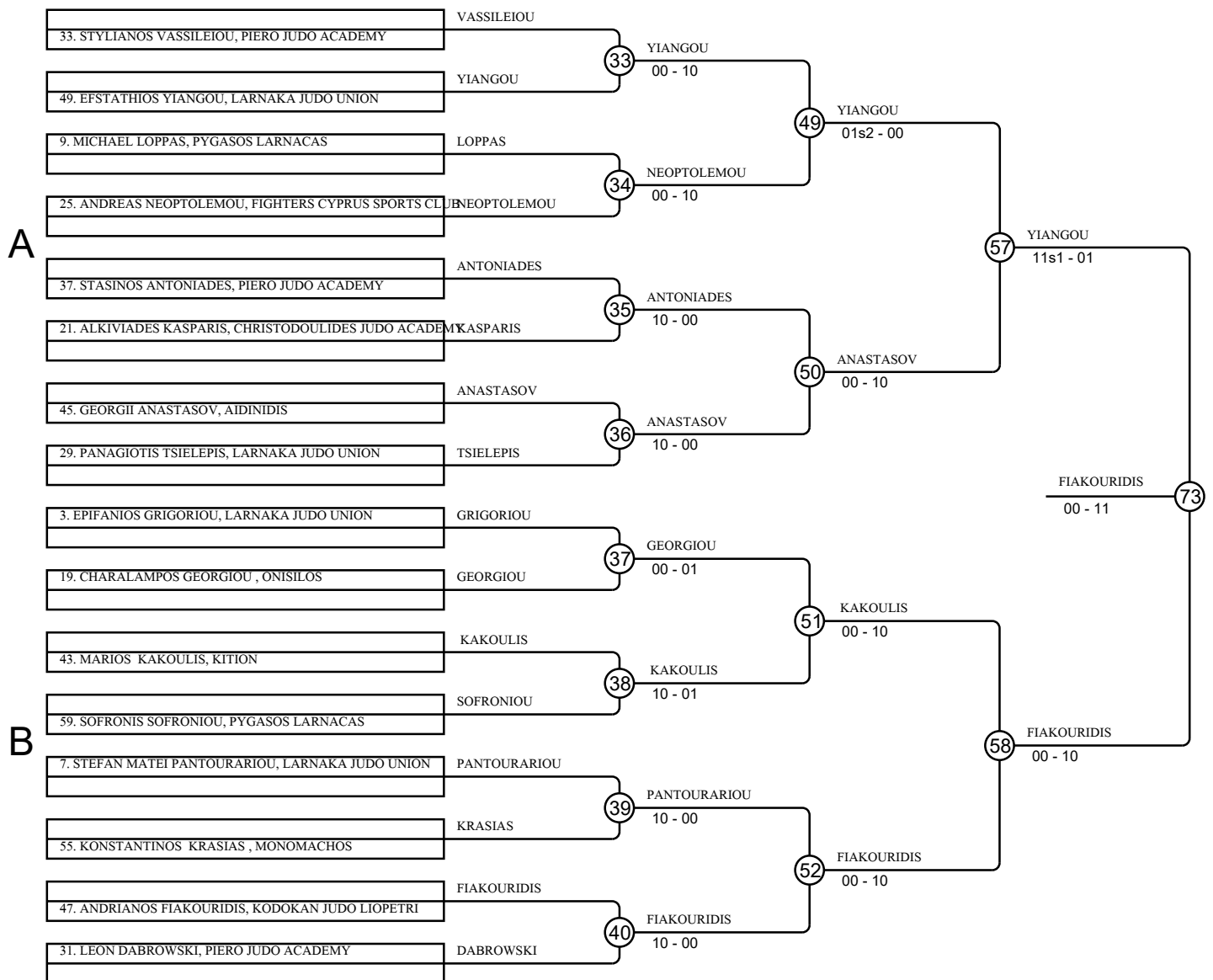

NATIONAL CHAMPIONSHIP U10 2022 09/04/2022 LEFKOTHEO BOYS U10-29

Competitors: 33

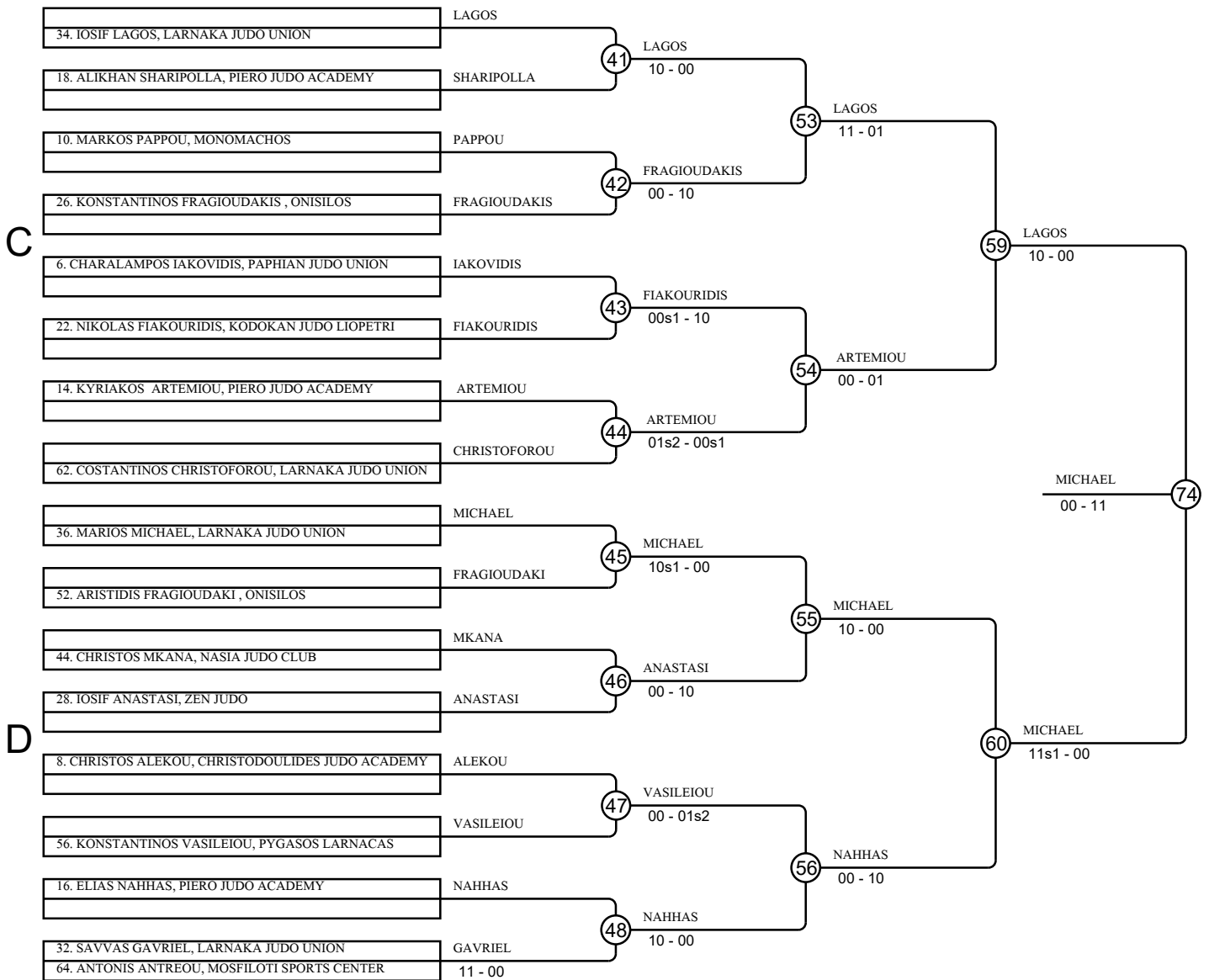

NATIONAL CHAMPIONSHIP U10 2022 09/04/2022 LEFKOTHEO BOYS U10-29

Competitors: 33

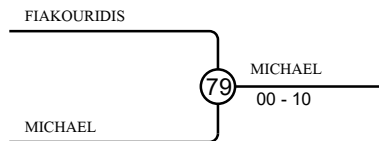
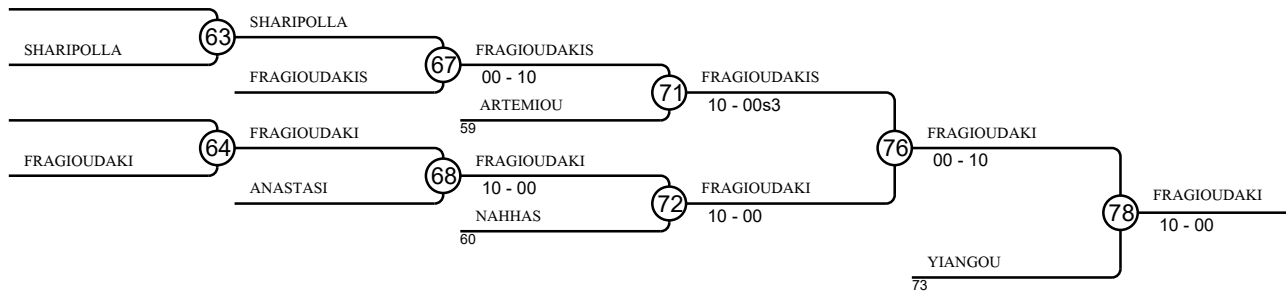
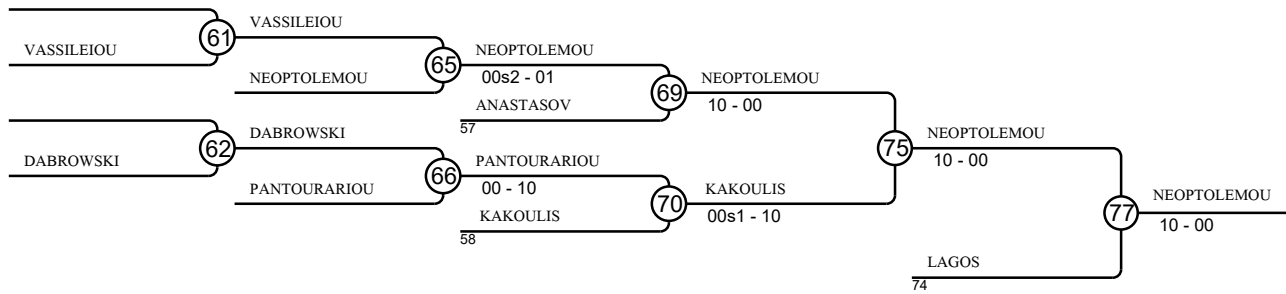

Results

Pos	Name
1	MARIOS MICHAEL, LARNAKA JUDO UNION
2	ANDRIANOS FIAKOURIDIS, KODOKAN JUDO LIOPETRI
3	ANDREAS NEOPTOLEMOU, FIGHTERS CYPRUS SPORTS CLUB
3	ARISTIDIS FRAGIOUDAKI, ONISILOS
5	IOSIF LAGOS, LARNAKA JUDO UNION
5	EFSTATHIOS YIANGOU, LARNAKA JUDO UNION
7	MARIOS KAKOULIS, KITION
7	KONSTANTINOS FRAGIOUDAKIS, ONISILOS

NATIONAL CHAMPIONSHIP U10 2022 09/04/2022 LEFKOTHEO BOYS U10-32

Competitors: 20

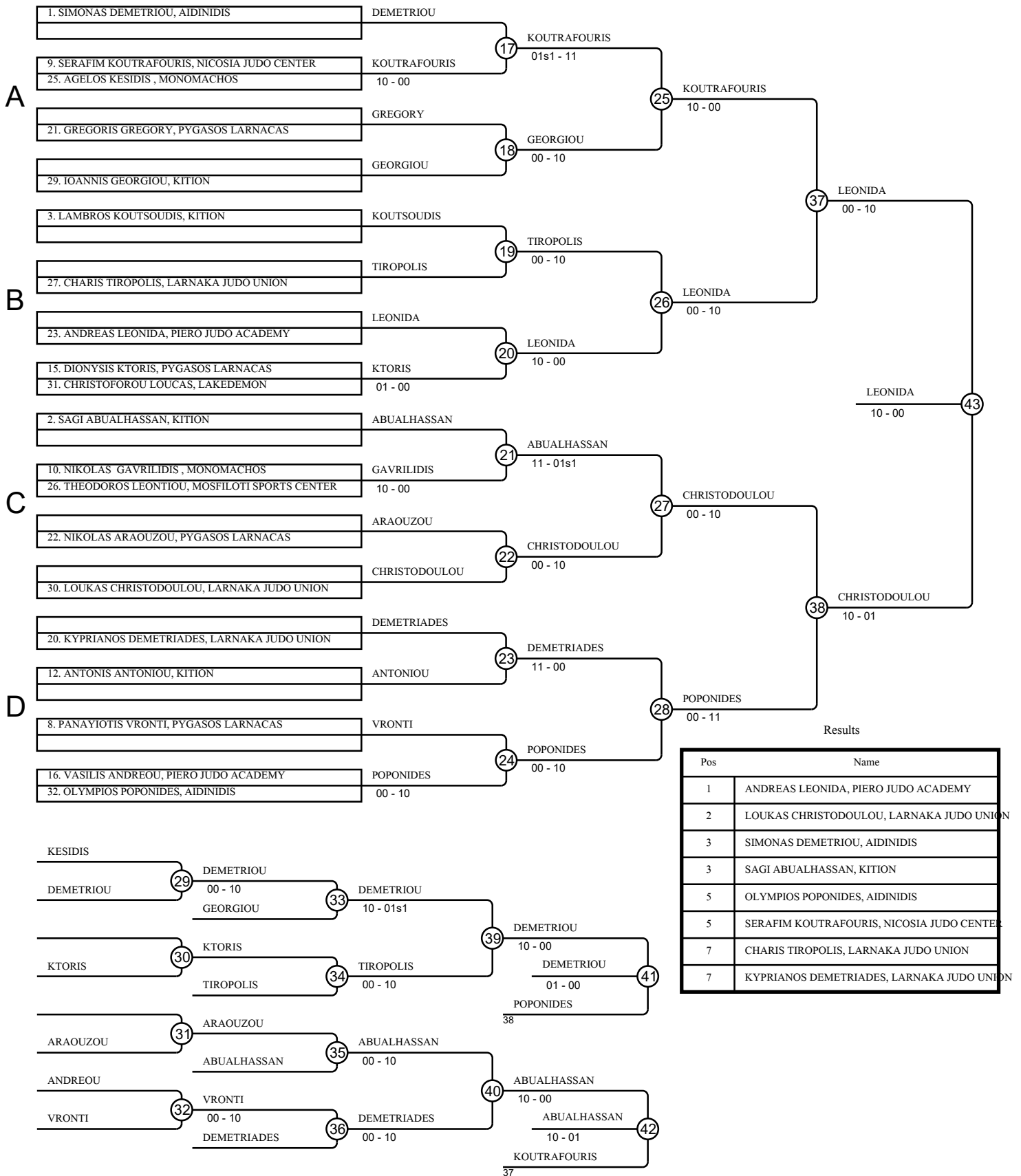

NATIONAL CHAMPIONSHIP U10 2022 09/04/2022 LEFKOTHEO BOYS U10-35

Competitors: 22

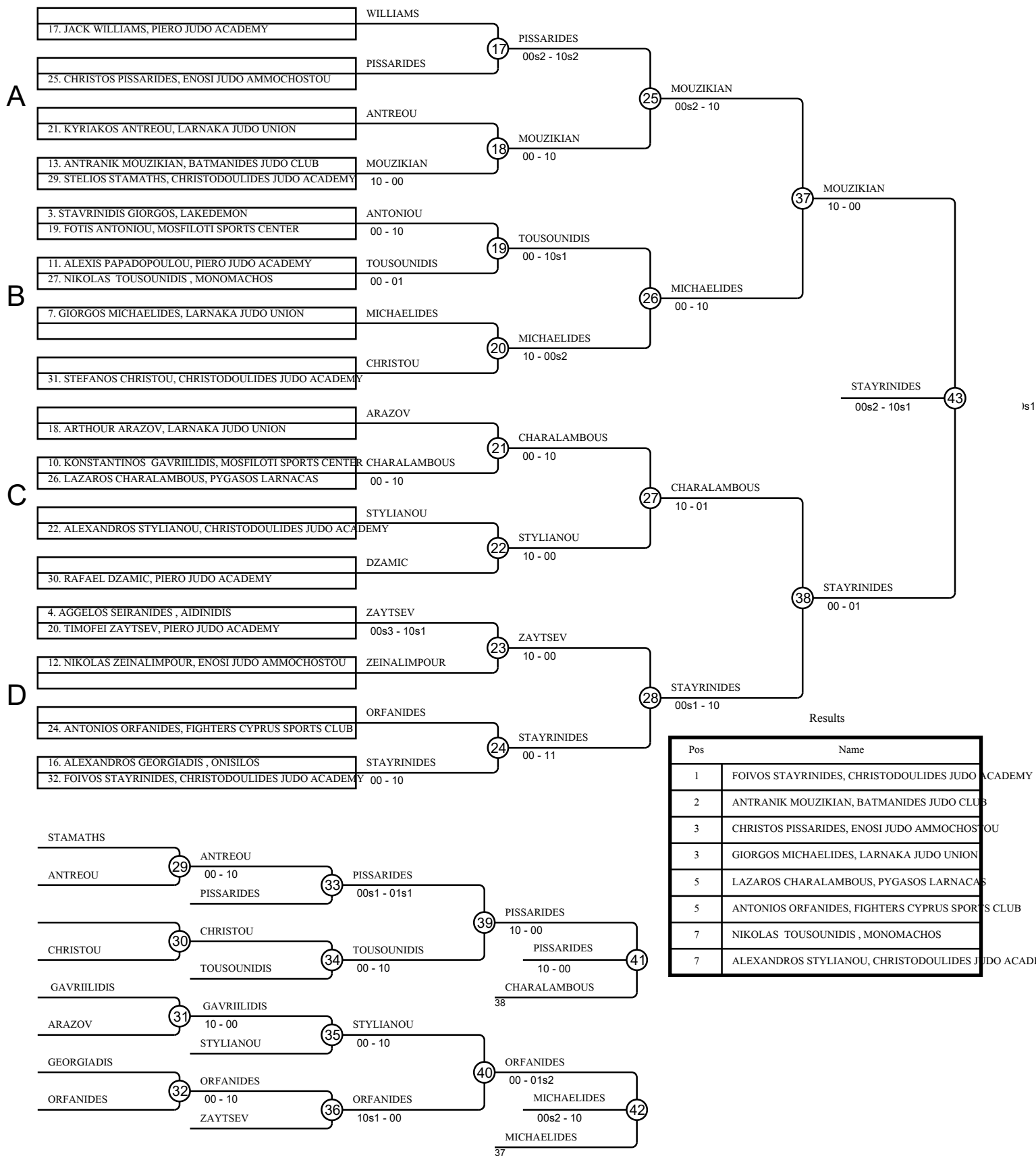

NATIONAL CHAMPIONSHIP U10 2022 09/04/2022 LEFKOTHEO BOYS U10-38

Competitors: 10

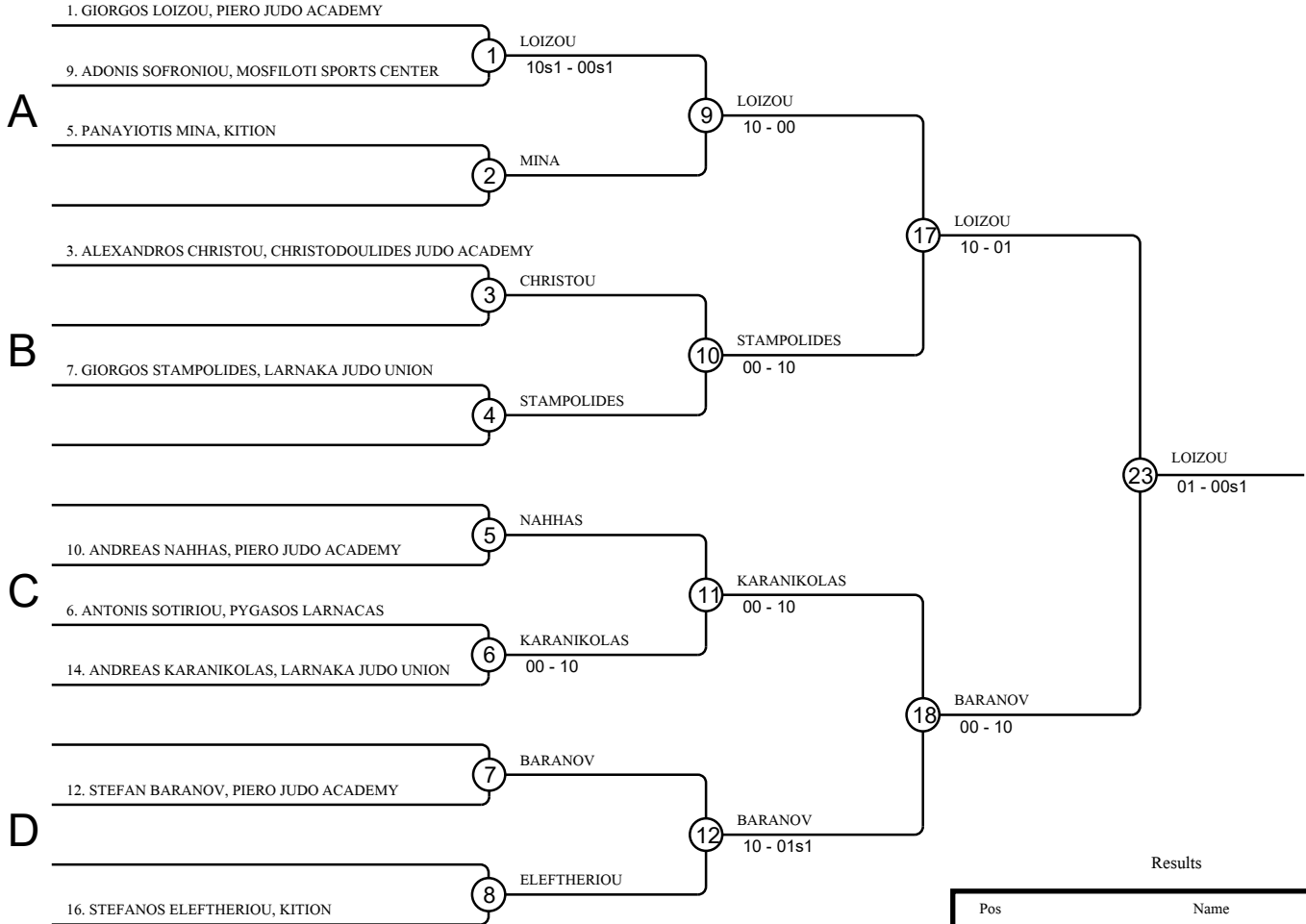

Results

Pos	Name
1	GIORGOS LOIZOU, PIERO JUDO ACADEMY
2	STEFAN BARANOV, PIERO JUDO ACADEMY
3	ALEXANDROS CHRISTOU, CHRISTODOULIDES JUDO ACADEMY
3	GIORGOS STAMPOLIDES, LARNAKA JUDO UNION
5	ANDREAS KARANIKOLAS, LARNAKA JUDO UNION
5	STEFANOS ELEFTHERIOU, KITION
7	ADONIS SOFRONIOU, MOSFILOTI SPORTS CENTER
7	ANDREAS NAHHAS, PIERO JUDO ACADEMY

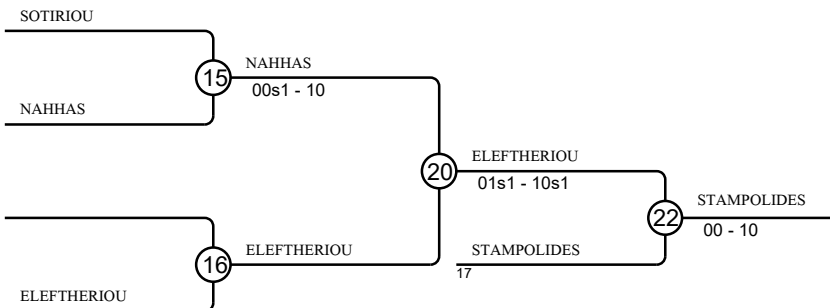
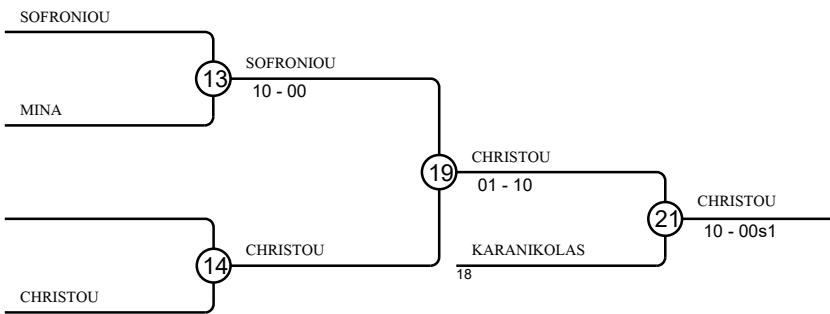

NATIONAL CHAMPIONSHIP U10 2022 09/04/2022 LEFKOTHEO BOYS U10-42

Competitors: 11

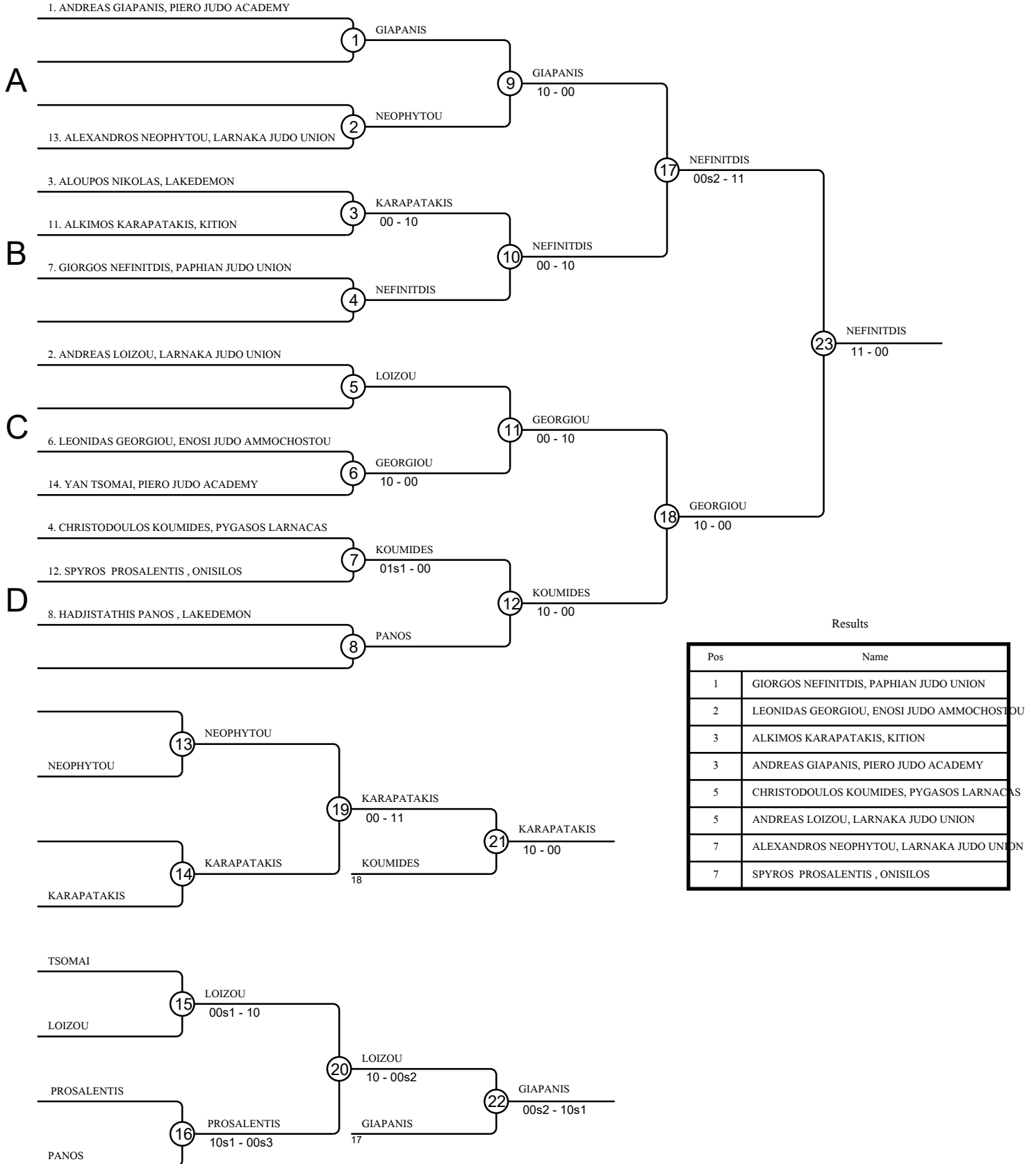

NATIONAL CHAMPIONSHIP U10 2022 09/04/2022 LEFKOTHEO BOYS U10-46

Competitors: 8

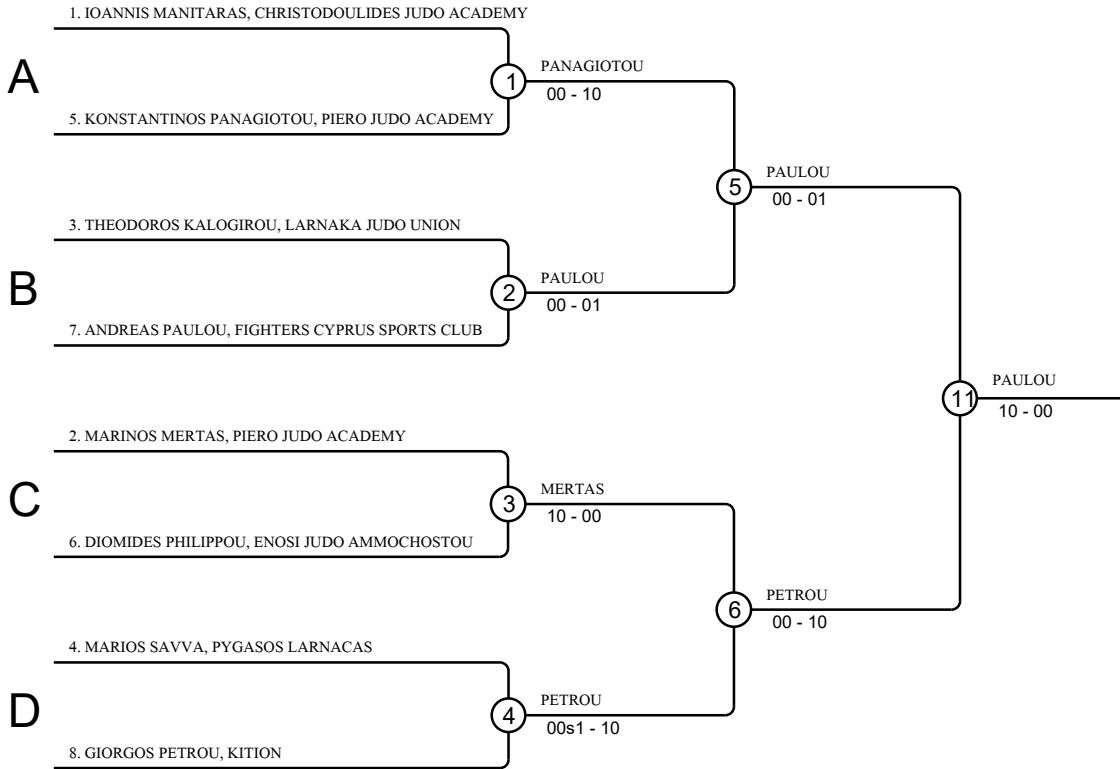

Results

Pos	Name
1	ANDREAS PAULOU, FIGHTERS CYPRUS SPORTS CLUB
2	GIORGOS PETROU, KITION
3	THEODOROS KALOGIROU, LARNAKA JUDO UNION
3	KONSTANTINOS PANAGIOTOU, PIERO JUDO ACADEMY
5	MARINOS MERTAS, PIERO JUDO ACADEMY
5	DIOMIDES PHILIPPOU, ENOSI JUDO AMMOCHOSTOU
7	IOANNIS MANITARAS, CHRISTODOULIDES JUDO ACADEMY
7	MARIOS SAVVA, PYGASOS LARNACAS

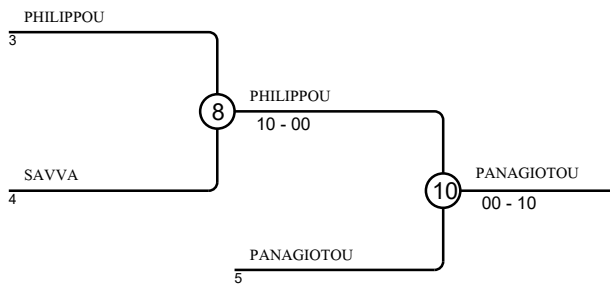
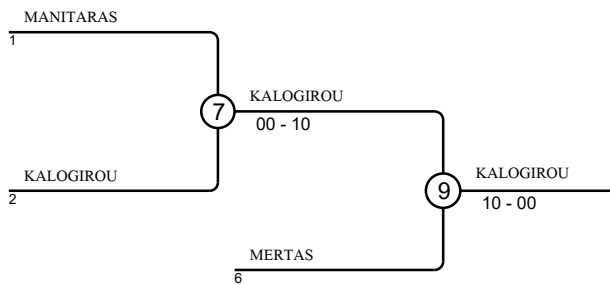

NATIONAL CHAMPIONSHIP U10 2022 09/04/2022 LEFKOTHEO BOYS U10-50

Competitors

Competitors: 2

#	Name	Club	1	2	1	2	1	2	Wins	Pts	Pos
1	NICOLAS KALENOS	LARNAKA JUDO UNION							0	0	2
2	GIORGOS CHRISTODOULOU	MONOMACHOS	10		10				2	20	1

Matches

Match	White		Blue		Result	Time
1	NICOLAS KALENOS	1	2	GIORGOS CHRISTODOULOU	00-10	0:50
2	NICOLAS KALENOS	1	2	GIORGOS CHRISTODOULOU	00s1-10	1:05
3	NICOLAS KALENOS	1	2	GIORGOS CHRISTODOULOU		

Results

Pos	Name
1	GIORGOS CHRISTODOULOU , MONOMACHOS
2	NICOLAS KALENOS, LARNAKA JUDO UNION

NATIONAL CHAMPIONSHIP U10 2022 09/04/2022 LEFKOTHEO BOYS U10-55

Competitors: 5

Competitors

#	Name	Club	1	2	3	4	5	Wins	Pts	Pos
1	FOTIS THEOFILOU	ZEN JUDO					10	1	10	4
2	SOTIRIS MASHINI	FIGHTERS CYPRUS SPORTS CLUB	10				1	2	11	3
3	OLYMPIOS IACOVOU	ENOSI JUDO LEMESOU	10	10		1	10	4	31	1
4	IOANNIS ANASTASIOS POLYDOROU	LARNAKA JUDO UNION	10	10				2	20	2
5	NIKOS EFTYMIU	LARNAKA JUDO UNION				10		1	10	5

Matches

Match	White		Blue	Result	Time
1	IOANNIS ANASTASIOS POLYDOROU	4	5	NIKOS EFTYMIU	01-10 1:50
2	FOTIS THEOFILOU	1	2	SOTIRIS MASHINI	00-10 0:54
3	OLYMPIOS IACOVOU	3	4	IOANNIS ANASTASIOS POLYDOROU	01s1-00s2 3:20
4	FOTIS THEOFILOU	1	5	NIKOS EFTYMIU	10-00 0:32
5	SOTIRIS MASHINI	2	3	OLYMPIOS IACOVOU	00-10s2 0:43
6	FOTIS THEOFILOU	1	4	IOANNIS ANASTASIOS POLYDOROU	00-10 0:08
7	OLYMPIOS IACOVOU	3	5	NIKOS EFTYMIU	10-00 0:55
8	SOTIRIS MASHINI	2	4	IOANNIS ANASTASIOS POLYDOROU	01-10 1:36
9	FOTIS THEOFILOU	1	3	OLYMPIOS IACOVOU	00-10 0:31
10	SOTIRIS MASHINI	2	5	NIKOS EFTYMIU	01-00s1 2:00

Results

Pos	Name
1	OLYMPIOS IACOVOU, ENOSI JUDO LEMESOU
2	IOANNIS ANASTASIOS POLYDOROU, LARNAKA JUDO UNION
3	SOTIRIS MASHINI, FIGHTERS CYPRUS SPORTS CLUB
4	FOTIS THEOFILOU, ZEN JUDO
5	NIKOS EFTYMIU, LARNAKA JUDO UNION

NATIONAL CHAMPIONSHIP U10 2022 09/04/2022 LEFKOTHEO BOYS U10+55

Competitors: 6

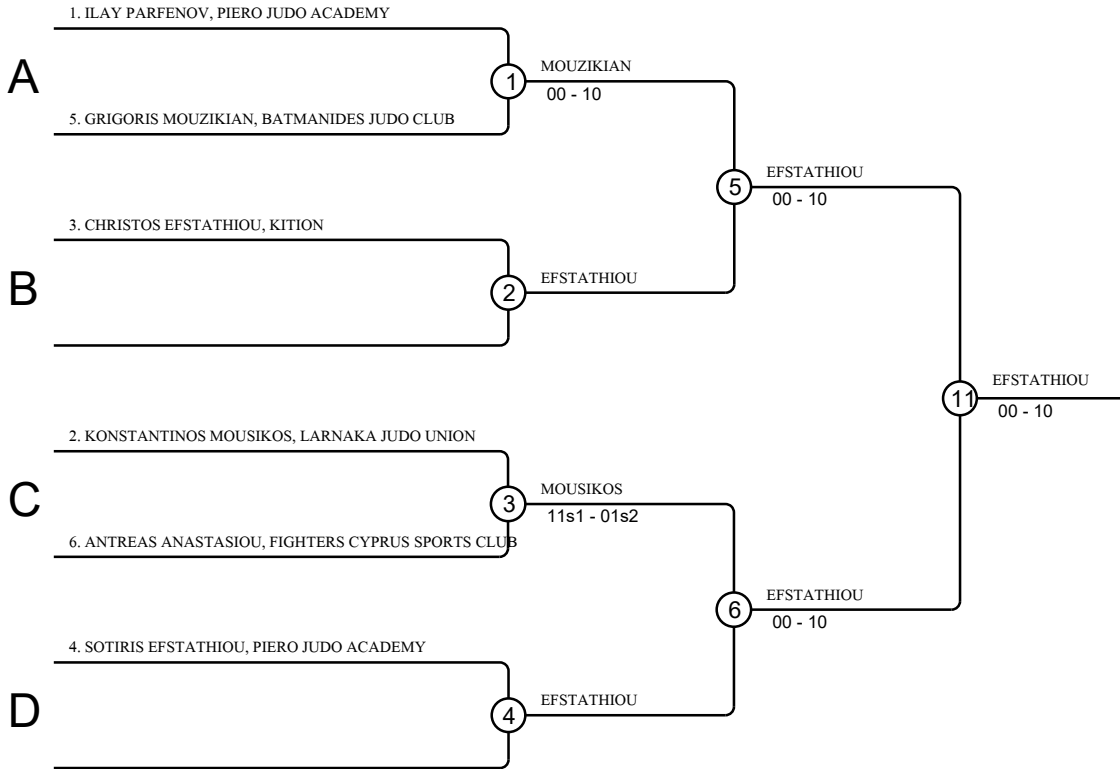

Results

Pos	Name
1	SOTIRIS EFSTATHIOU, PIERO JUDO ACADEMY
2	CHRISTOS EFSTATHIOU, KITION
3	KONSTANTINOS MOUSIKOS, LARNAKA JUDO UNION
3	GRIGORIS MOUZIKIAN, BATMANIDES JUDO CLUB
5	ILAY PARFENOV, PIERO JUDO ACADEMY
5	ANTREAS ANASTASIOU, FIGHTERS CYPRUS SPORTS CLUB
7	
7	

